

# TXG13c Facts and Data

## Digital Color Matrix Camera, 1.4 Megapixels, Gigabit Ethernet

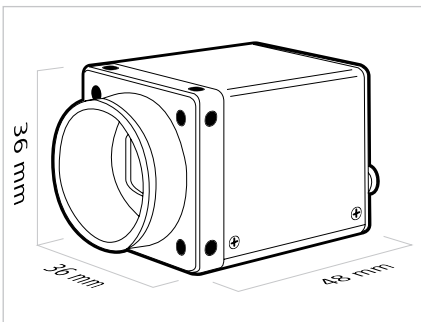

Baumer Optronic GmbH  
 Badstrasse 30  
 DE-01454 Radeberg, Germany  
 Phone +49 (0)3528 4386 0  
 Fax +49 (0)3528 4386 86  
 sales@baumeroptronic.com  
 www.baumer.com/cameras

### Sensor Information

Model Name	SONY® ICX267
Type	1/2" interline progressive scan CCD
Native Resolution	1384 × 1036 pixels
Exposure Time	4 µsec ... 60 sec
Color Filter	RGB Bayer Mosaic

### Acquisition Formats

Image Formats	Full Frame HQ Full Frame	1384 × 1036 pixels 1384 × 1036 pixels	max. 10.0 fps max. 20.0 fps
Pixel Formats <sup>1)</sup>	Mono8, BayerRG8, BayerRG12, RGB8 Packed, BGR8 Packed, YUV411 Packed, YUV422 Packed, YUV444 Packed		
Partial Scan	True Partial Scan, Region of Interest (ROI) arbitrary		

### Image Pre-processing

Analog Controls	Gain (0 ... 20 dB), Offset (0 ... 255 LSB   12 bit)
Color Models	RGB, YUV, Mono
Color Processing	Integrated color processor for high quality color calculation
Color Adjustment	One Push White Balance, User-specific color adjustment

### Camera Features

Internal Buffer	32 MBytes (max. 3 images)
Synchronization	Free running, Trigger
Trigger Sources	Hardware, Software, ActionCommand
Trigger Delay	0 ... 2 sec, Tracking and buffering of up to 512 trigger signals
Digital I/Os	1 input line (with Debouncer), 1 output line

### Interfaces and Connectors

Data Interface	Gigabit Ethernet, Transfer rate 1000 Mbits/sec Connector: 8P8C Modular Jack (RJ45), screw lock type
Process Interface	M8 / 4 pins
Power Interface	M8 / 3 pins

### Mechanical Data

Housing	Aluminum, IP40
Lens Mount	C-Mount
Dimensions	36 × 36 × 48 mm
Weight	< 90 g

### Electrical Data

Power Supply	8 ... 30 V DC
Power Consumption	approx. 4 Watts

### Environmental Data

Operating Temperature	+5 °C ... +50 °C (+41 °F ... +121 °F)
Humidity	10% ... 90% non condensing

<sup>1)</sup> Depending on the adjusted Image Format